

NOTICE TECHNIQUE

- GAMME TOKYO -
PORTAIL COULISSANT

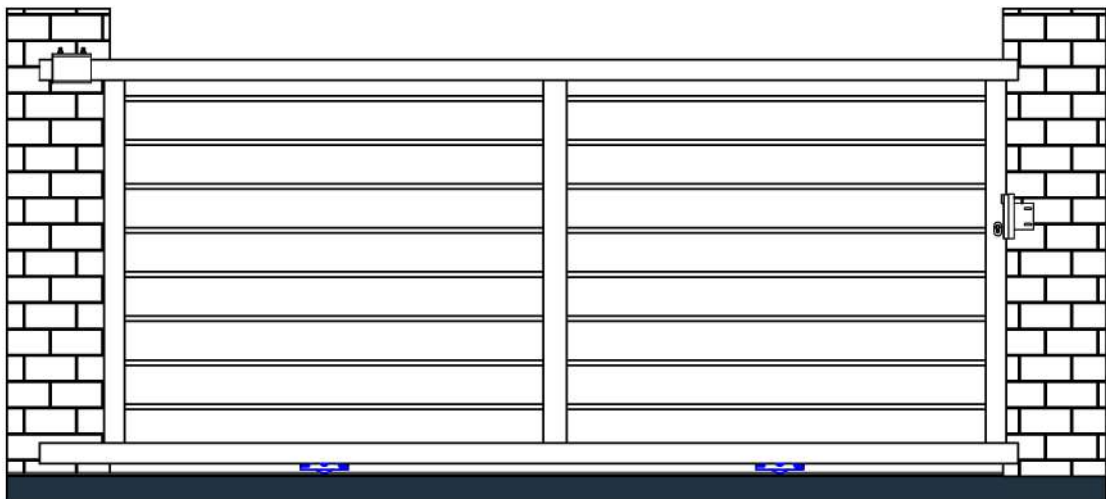

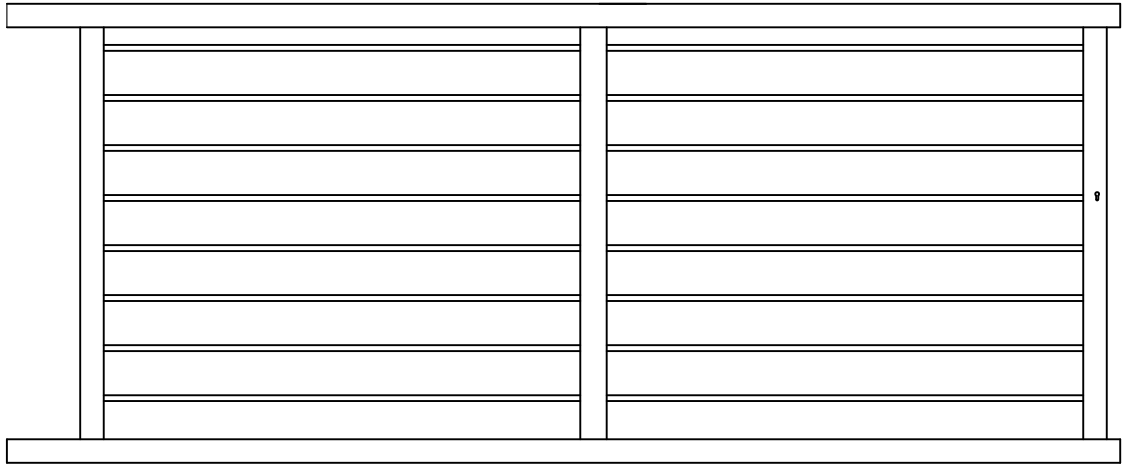

[1]*1

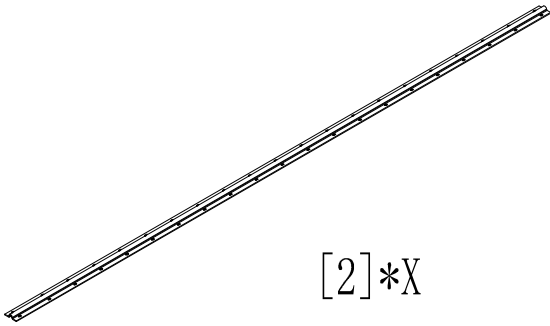

[2]*X



[3]*1

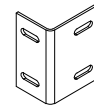

[4]*1



[5]*2

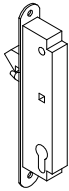

[6]*1

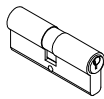

[7]*1



[8]*4



[9]*3

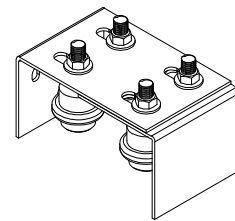

[10]*1

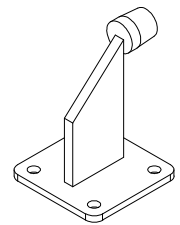

[11]*1

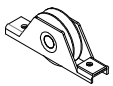

[12]*2

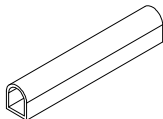

[13]*X

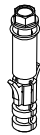

[14]*X



[15]*9



[16]*3

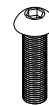

[17]*4

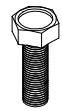

[18]*2

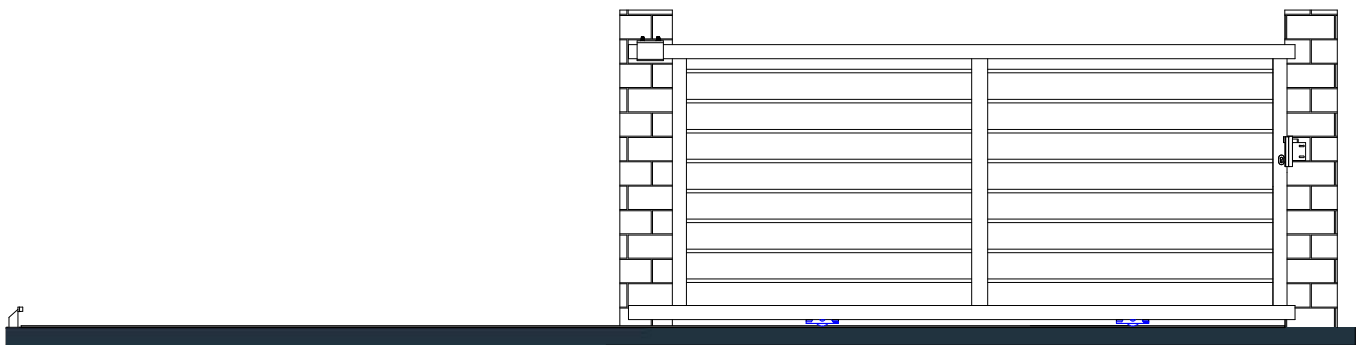
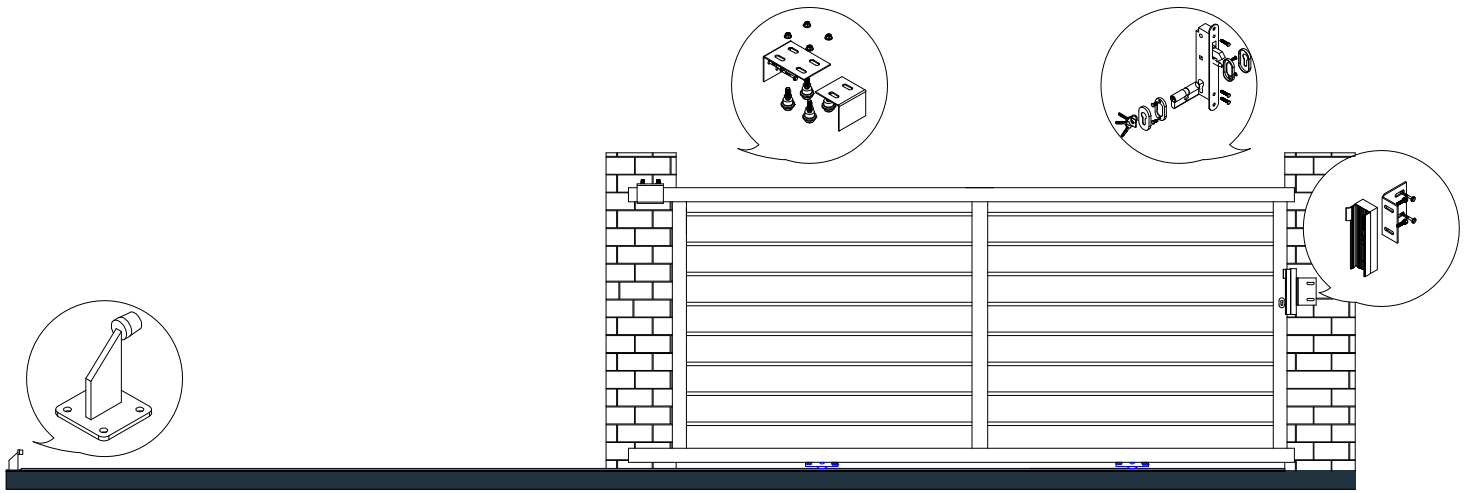

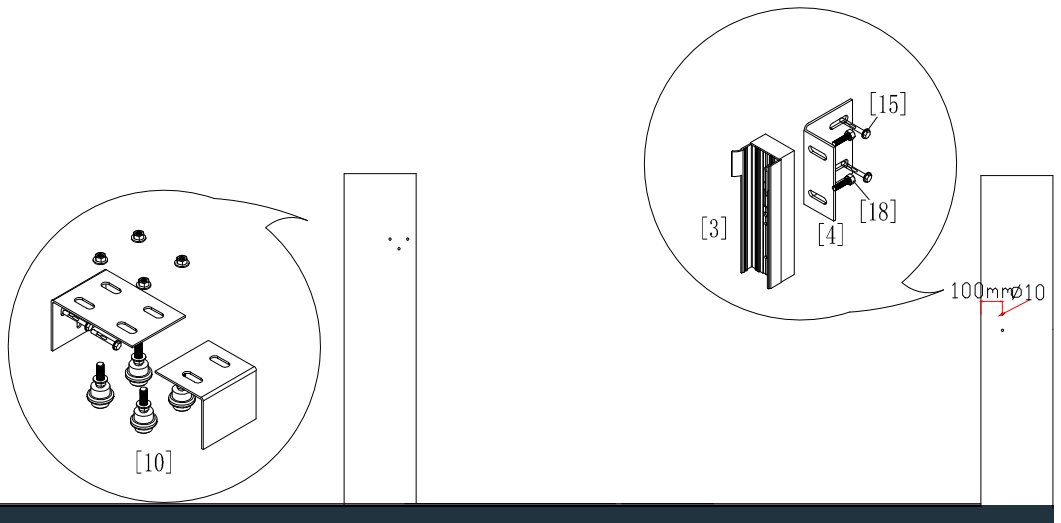
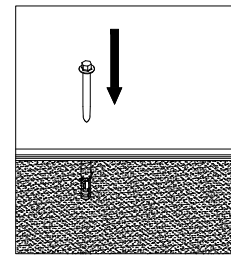
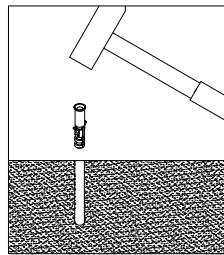
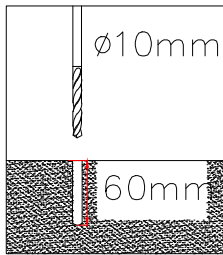
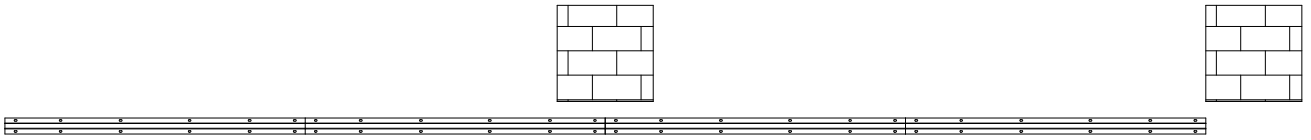
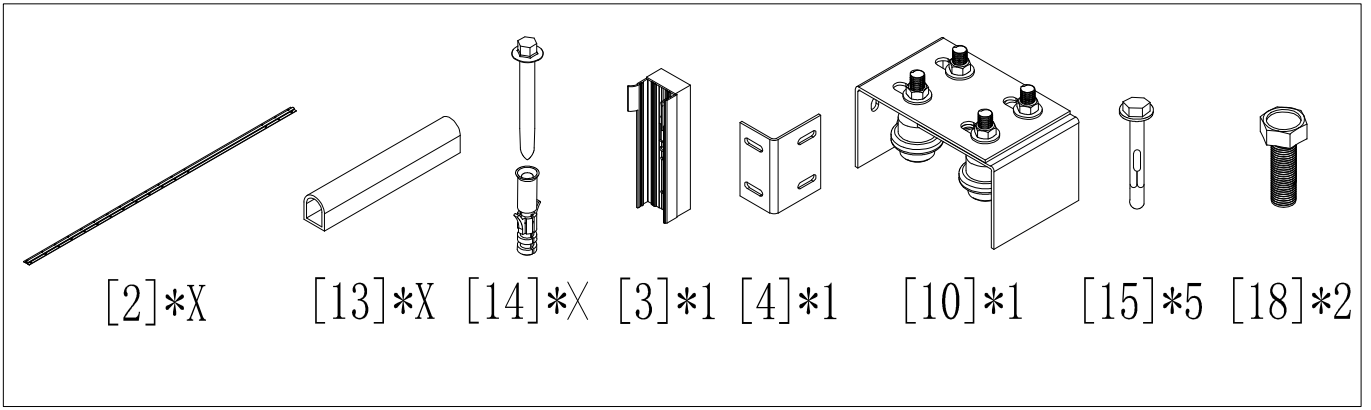

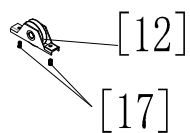
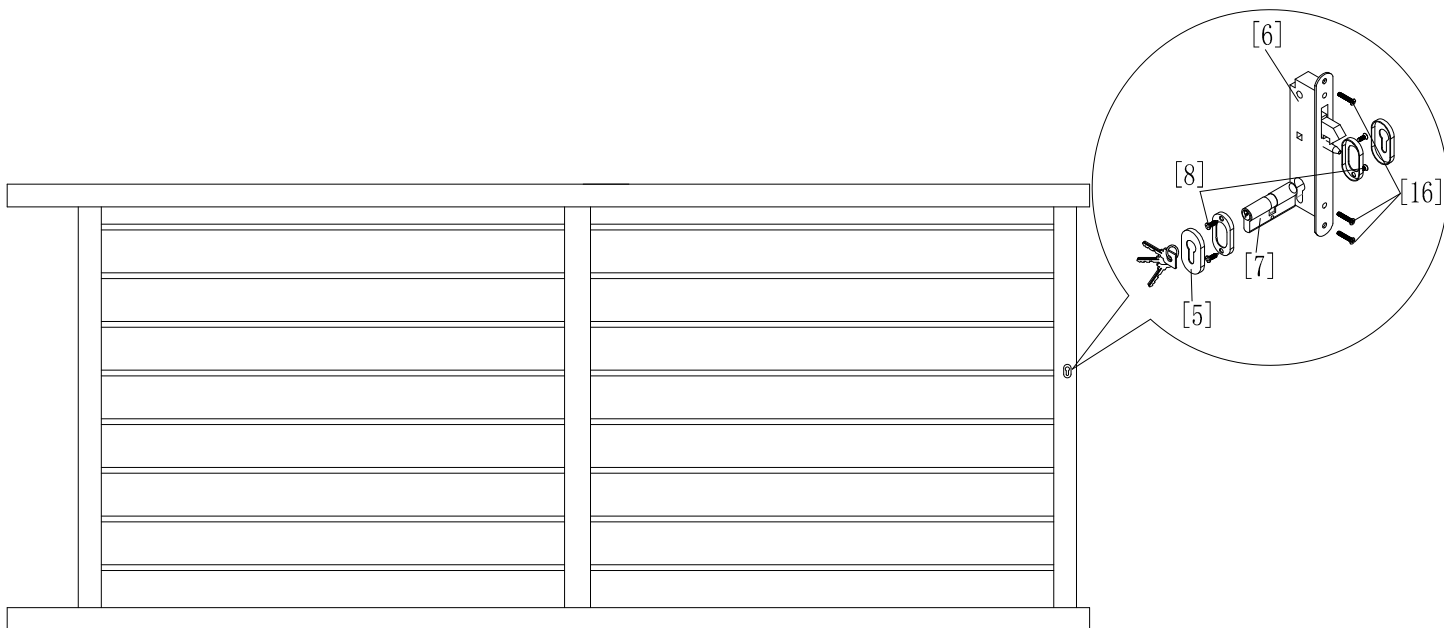
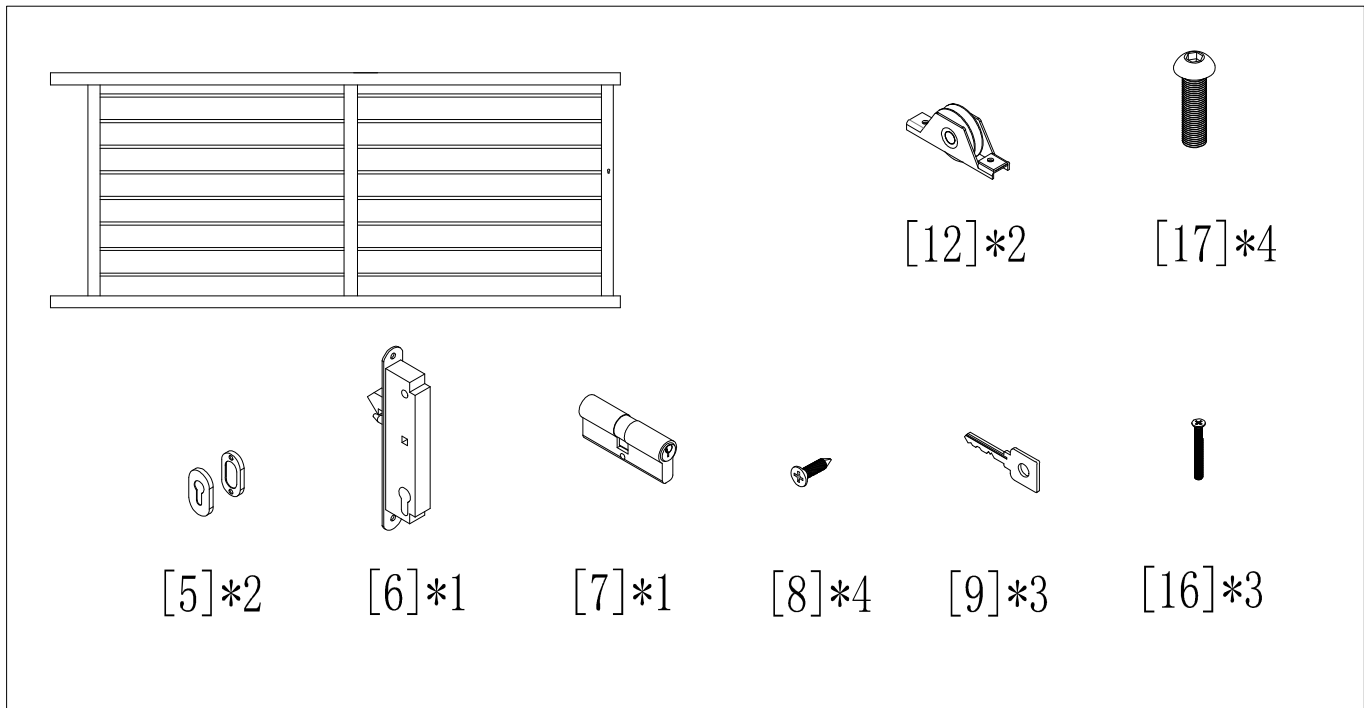

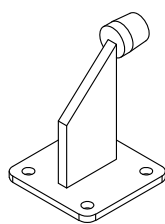

[11]*1

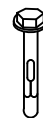

[15]*4

